

DESIGN Guido Faleschini – 1985



Scrivanie. I piani e le gambe sono realizzati con pannelli tamburati realizzati con bordi e traversi in massello di faggio, cartone a nido d'ape e pannelli di nobilitato nero. Il top può essere rivestito completamente in cuoio (non in pelle) oppure in cristallo retro verniciato nero con bordi in cuoio (non in pelle). Le gambe sono in nobilitato nero a vista con parti rivestite in cuoio.

Cassettiere e allungo. Strutture in nobilitato nero a vista. Frontali dei cassetti, top, schienale e piedini sono in nobilitato nero e sempre rivestiti in cuoio (non in pelle). Cassetti in multistrato laccati neri. Maniglie in acciaio con dettaglio di cuoio.

Mobili. Strutture in nobilitato nero a vista. Top e frontali di cassetti ed ante sono realizzati in nobilitato nero rivestiti in cuoio (non in pelle); le ante sono disponibili anche in cristallo fumé con cornice rivestita in cuoio. Cassetti in multistrato laccati neri. Maniglie in acciaio con dettaglio di cuoio.

Cuoio. In base alla categoria di cuoio scelta, la misura dei diversi "tagli" dello stesso può variare in maniera sensibile.

Desks. The tops and the legs are made with honeycomb panels made with edges and crosspieces in solid beechwood, honeycomb cardboard and black melamine coated panel. The top can be covered completely in saddle leather (not soft leather), or in black back-painted glass with saddle leather edges (not in soft leather). The legs are in visible black melamine coated panel with some parts covered in saddle leather.

Pedestal and return cabinet. Frame in visible black melamine coated panels. Drawer fronts, top, back and feet are made in black melamine coated panels and covered in saddle leather (not soft leather). Drawer's frame in black lacquered plywood. Steel handles with saddle leather detail.

Cabinets. Frame in visible black melamine coated panels. Top and fronts of drawers and doors are made in black melamine coated panels and covered in saddle leather (not soft leather); the doors are available also in smoked glass with frame covered in saddle leather. Drawer's frame in black lacquered plywood. Steel handles with saddle leather detail.

Saddle leather. Depending on the category of saddle leather chosen, the size of its different "cuts" can vary significantly.

SCRIVANIE – DESKS

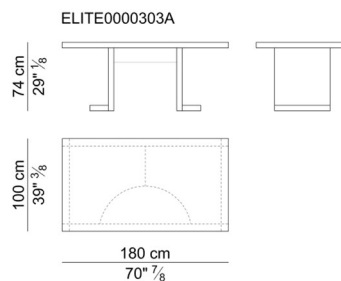
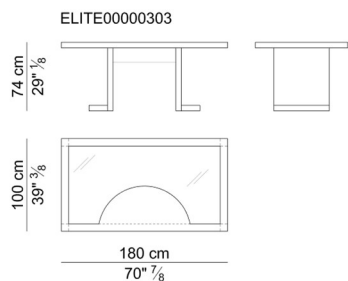
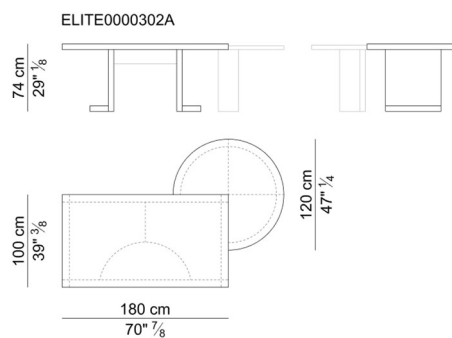
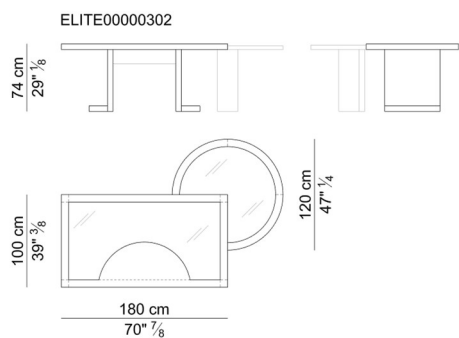
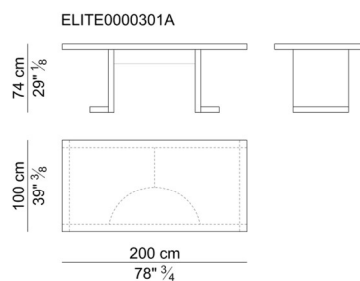
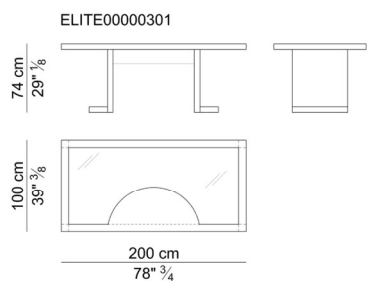
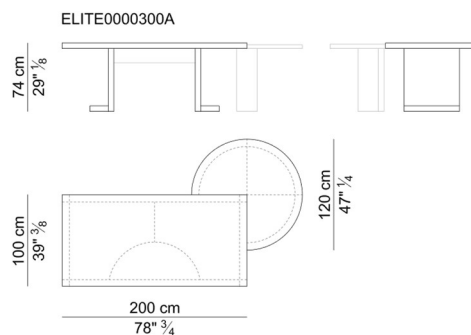
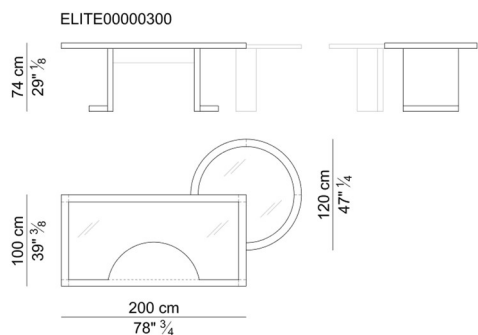

CASSETTIERE FISSE – FIXED PEDESTALS

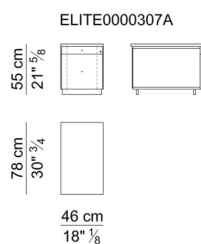
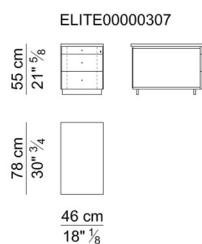

MOBILE ALLUNGO – SIDEBORD CABINET

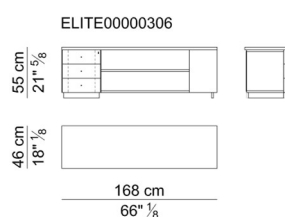

MOBILI BASSI– LOW CABINETS

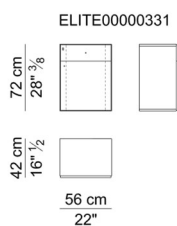
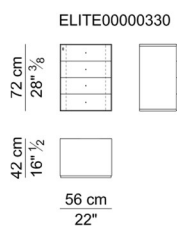
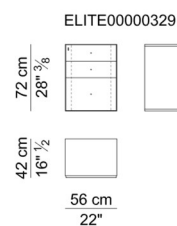
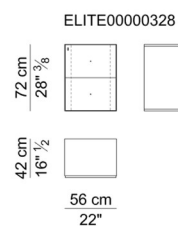
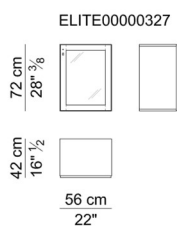
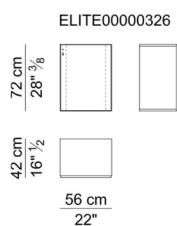

TOP PER MOBILI BASSI– TOP FOR LOW CABINETS

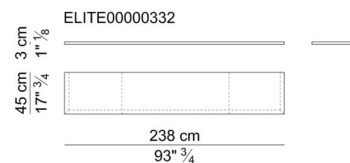
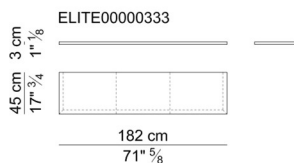
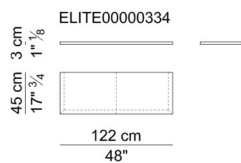

ELEMENTI DI ASSEMBLAGGIO PER MOBILI BASSI – ASSEMBLY ELEMENTS FOR LOW CABINETS

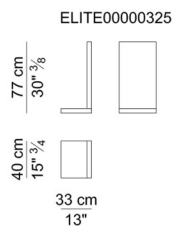
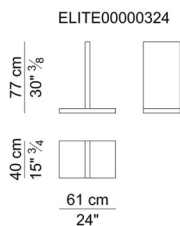

MOBILI ALTI – HIGH CABINETS

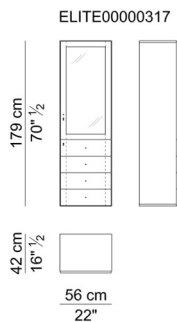
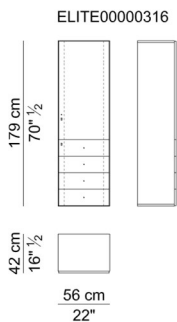
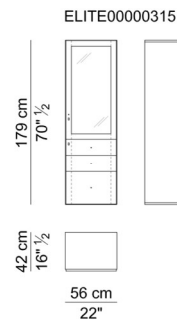
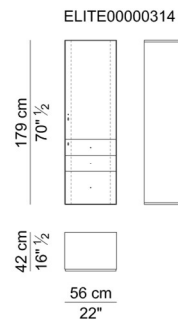
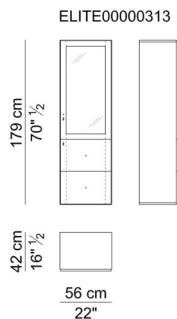
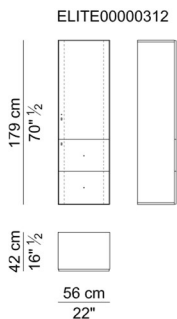
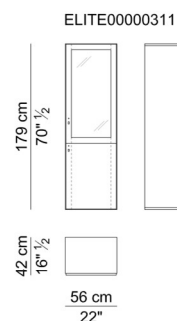
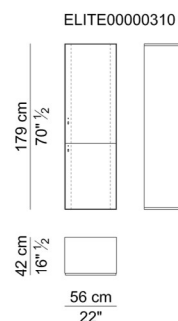
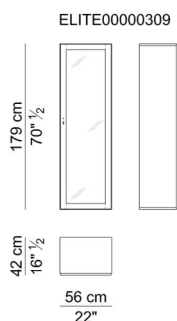
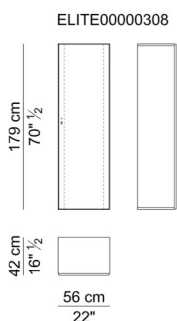

TOP PER MOBILI ALTI – TOP FOR HIGH CABINETS

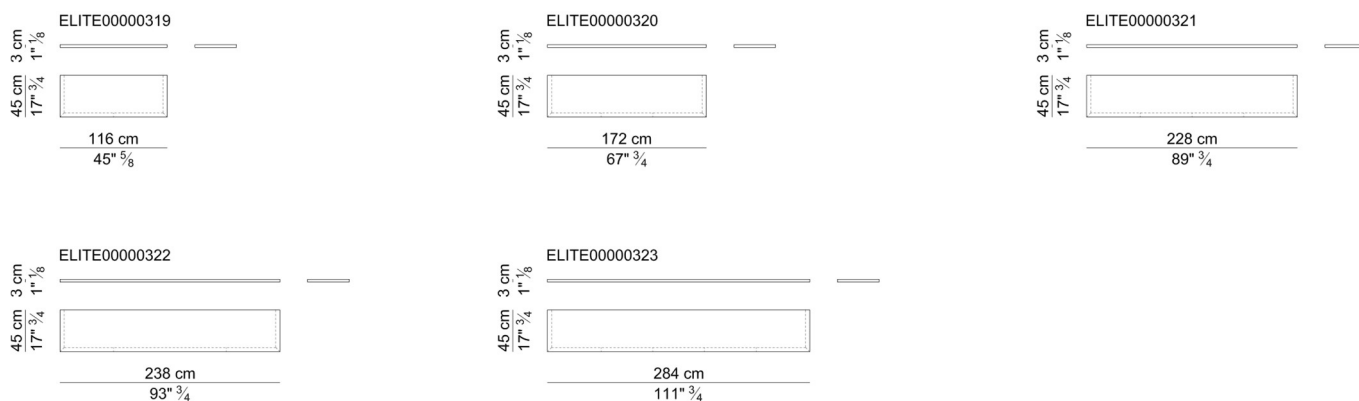

ELEMENTO A GIORNO PER MOBILI BASSI CON MOBILI ALTI – OPEN ELEMENT FOR LOW CABINETS WITH HIGH CABINETS

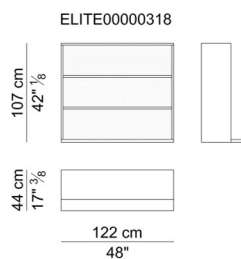

BANCONE E MOBILE BAR – BAR COUNTER AND BAR CABINET

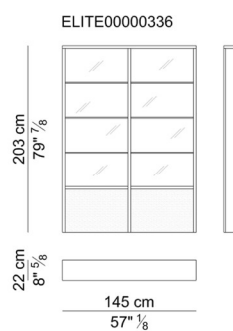
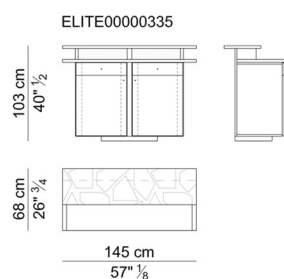

TAVOLO PER COMPUTER – COMPUTER TABLE

